

DesignMax DM2S

surface-mounted loudspeaker

Product Overview

DesignMax loudspeakers bring outstanding audio and aesthetics to any commercial space. Ideal for background music, the 16-watt DesignMax DM2S loudspeaker features a 2.25-inch transducer and 85 Hz - 19 kHz frequency range. The DM2S is surface-mounted and locks onto a hidden QuickHold U-bracket for fast, secure installation. With both black and white versions available, the DM2S is easy to integrate with any décor.



Key Features

Deliver instantly impressive sound with custom Bose drivers — no DSP or EQ required. For even better sound, use select Bose DSPs and amplifiers to enable Bose loudspeaker EQ and SmartBass processing, which expands performance and response at any listening level

Blend into any room design with elegant form factors, minimum-bezel grilles available in black or white, and removable logos

Reduce installation time with the patented QuickHold mounting system, which also reduces strain, hassle, and the chance of product damage

Install easily — includes Euroblock connectors; that makes installation and troubleshooting easier

Amplifier flexibility — 16 ohm feature allows for four units on a single low impedance line

Technical Specifications

SINGLE LOUDSPEAKER PERFORMANCE		
Frequency Response (-3 dB) ⁽¹⁾	95 - 18,000 Hz	
Frequency Range (-10 dB) ⁽¹⁾	85 - 19,000 Hz	
Nominal Coverage Angle (H x V) ⁽²⁾	180° x 155°	
Nominal Coverage Angle (1 - 10 kHz)	160° x 135°	
	Bose extended-lifecycle test ⁽⁵⁾	AES component test ⁽⁶⁾
Power Handling, long-term continuous	16 W	20 W
Power Handling, peak	64 W	80 W
Sensitivity (SPL/1W @ 1 m) ⁽³⁾	82 dB	82 dB
Calculated Maximum SPL @ 1 m ⁽⁴⁾	94 dB	95 dB
Calculated Maximum SPL @ 1 m, peak	100 dB	101 dB
Loudspeaker EQ	Not Required, Bose EQ voicing and SmartBass processing available	
Recommended High-Pass Protection	85 Hz with recommended 24 dB / octave filter	
Transformer taps	70V: 1.2, 2.3, 4.5, 9 W, bypass 100V: 2.3, 4.5, 9 W, bypass	
TRANSDUCERS		
Full-Range Driver	1 x 2.25-inch woofer (57 mm)	
Nominal Impedance	16 ohms (transformer bypass)	

DesignMax DM2S

surface-mounted loudspeaker

PHYSICAL	
Enclosure Material	Engineered plastics, UV fade resistant
Bracket Material	Powder-coated steel
Grille	Magnetically attached perforated steel, powder-coated finish, paintable, tamper-resistant design, includes safety-tether
Logo	Rotatable, removable
Color	Black: RAL 9005, White: Bose Arctic White, similar to RAL 9003, Paintable
Environmental	Indoor only
Safety Agency	UL-1480A, S5591/ UL Listed, NFPA70, in accordance with IEC60268-5, ROHS, CE compliant
Operating Temperature Range	0 °C to 50 °C (32 °F to 122 °F)
Connectors	Euroblock 6-pin connector with loop-through, mounted on rear. Accepts 18 AWG (0.8 mm ²) to 14 AWG (2.5 mm ²) size wire
Suspension / Mounting	QuickHold Mounting system with included U-Bracket
	4 preset mounting angles: 0°, 15°, 30°, 45°, for wall or ceiling placement
	Two (2) rear M6 screw inserts for safety cable or use with optional Pan & Tilt Bracket
Dimensions (H × W × D)	182 × 113 × 116 mm (7.1 × 4.4 × 4.5 in)
Dimensions (H × W × D) with bracket	182 × 113 × 128 mm (7.1 × 4.4 × 5.0 in)
Net Weight, Loudspeaker with grille	1.31 kg (2.90 lbs)
Shipping Weight, Pair	3.94 kg (8.70 lbs)
Included Accessories	U-Bracket, powder-coated steel
Optional Accessories	Pan & Tilt Bracket
PRODUCT CODES	
815013-0110	DESIGNMAX DM2S PAIR BLK
815013-0210	DESIGNMAX DM2S PAIR WHT

Footnotes

- (1) Frequency response and range measured on-axis in half-space environment with Bose EQ voicing
- (2) 1 kHz to 4 kHz average
- (3) Sensitivity measured on-axis in half-space environment with Bose EQ voicing
- (4) Maximum SPL calculated from sensitivity and power handling specifications, exclusive of power compression.
- (5) Bose extended-lifecycle test using pink noise filtered to meet IEC268-5, 6-dB crest factor, 500-hour duration.
- (6) AES standard 2-hour duration with IEC system noise

For additional specifications and application information, please visit PRO.BOSE.COM.
Specifications subject to change without notice. 04/2020

DesignMax DM2S

surface-mounted loudspeaker

On-Axis Frequency Response (half-space (2π) with Bose EQ voicing)

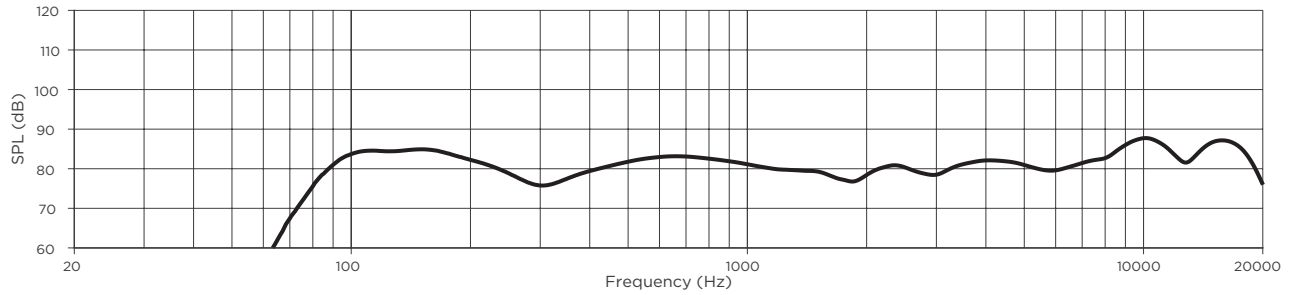

Impedance

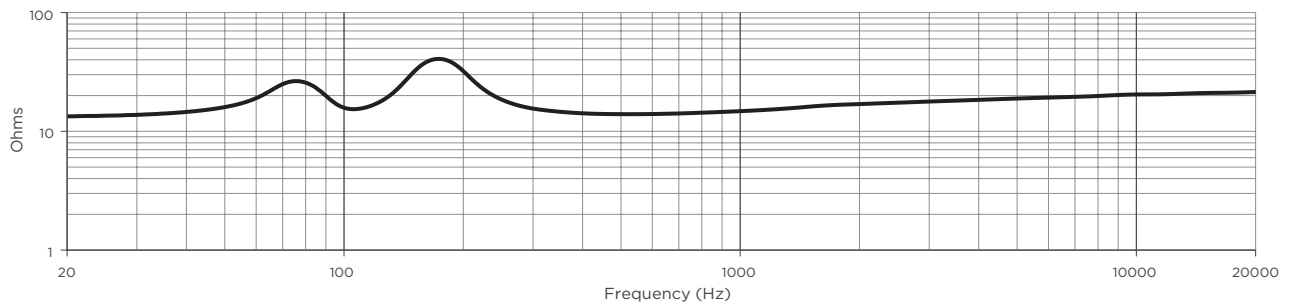

Beamwidth

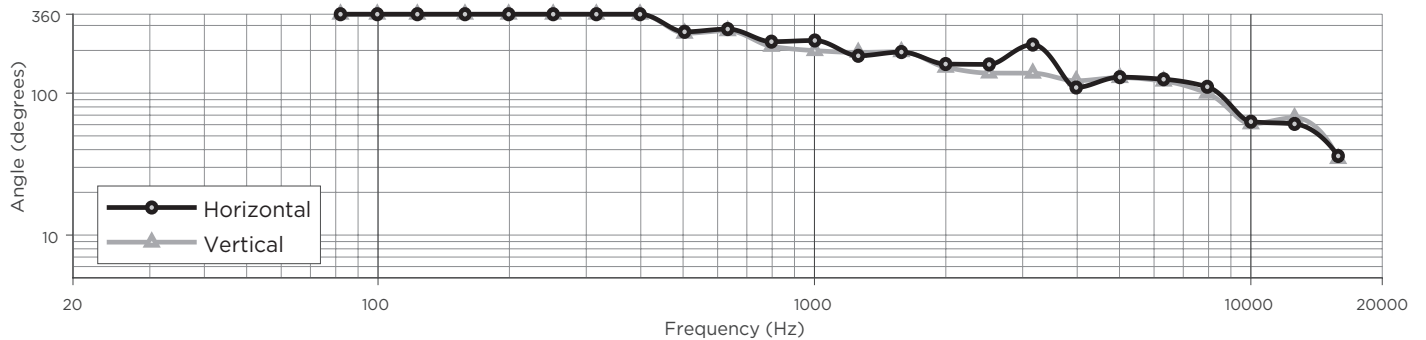

For additional specifications and application information, please visit PRO.BOSE.COM. Specifications subject to change without notice. 04/2020

DesignMax DM2S

surface-mounted loudspeaker

Dimensions

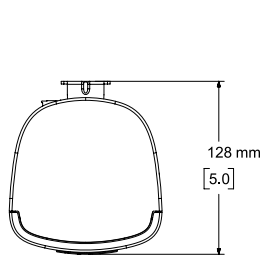

Top View

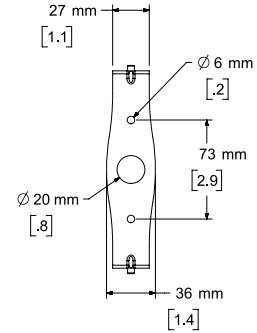
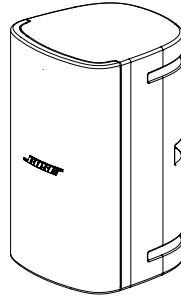

**Rear View
BRACKET ONLY**

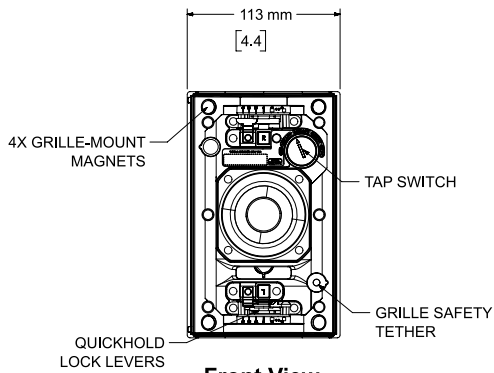

**Front View
GRILLE REMOVED FOR CLARITY**

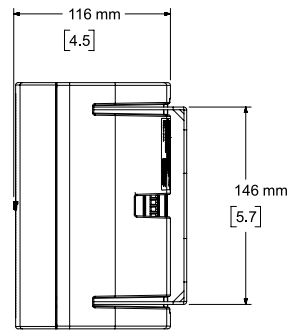

**Right View
DIMENSIONS APPLY TO BOTH SIDES**

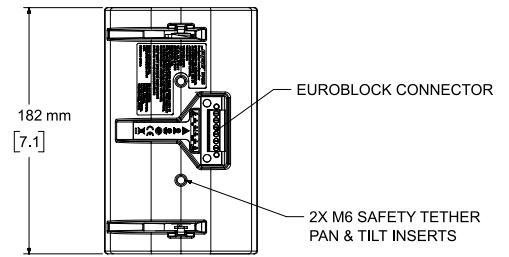

**Rear View
BRACKET REMOVED FOR CLARITY**

- NOTES:
 1. DIMENSIONS ARE IN MILLIMETERS OVER INCHES
 2. WEIGHT APPROX 1.31kg [2.9lbs] (SPEAKER ONLY)
 WEIGHT W/BRACKET APPROX 1.45kg [3.2lbs]